

# TECHNICAL DATA SHEET - G&G Bag HOUSE FILTER

<b>Filter type:</b>	G&G-Bag-HOUSE-6-6-152-25-A
<b>Producer:</b>	G&G filtration CZ, s.r.o.

## Parameters of filtered gas

A1	Operating amount of filtered gas	2 600 m <sup>3</sup> /h
A2	Operating temperature	20 °C
A3	Amount of filtered gas (0°C)	2 430 Nm <sup>3</sup> /h
A4	Inlet dust concentration	300 g/m <sup>3</sup>
A5	Operating pressure drop	1 200 Pa
A6	Maximum pressure drop	2 200 Pa

## Filter media parameters

B1	Shape of filter medium	round hoses
B2	Type of filter medium	m-Aramide
B3	Density of filter medium	530 g/m <sup>2</sup>
B4	Breathability filter media	300 mm/s @ 200 Pa
B5	Continuous temperature resistance	200 °C
B6	Momentary temperature resistance	220 °C

## Filter equipment parameters

C1	Number of filter rods	36 ks
C2	Total filter area	43 m <sup>2</sup>
C3	A/C parameter	1,01 m <sup>3</sup> /m <sup>2</sup> /min
C4	Can velocity	0,60 m/s
C5	Flow from below the rods	2 600 m <sup>3</sup> /h
C6	Hose side flow	- m <sup>3</sup> /h
C7	Polluted gas input	<i>into the filter hopper</i>

## Dimensions of the filter part

D1	X-axis filter size	1 392 mm
D2	Y-axis filter size	1 327 mm
D3	The gap between the individual rods	55 mm
D4	Gap between filter rods with filter walls	70 mm
D5	Gap between rods and hopper	100 mm

## Filter media arrangement

E1	Orientation of filter rods	<i>vertical</i>
E2	Diameter of filter rods	152 mm
E3	Length of filter rods	2 500 mm
E4	Rods attachment	<i>snapping</i>
E5	Inlet nozzle shape	<i>venturi</i>

## Regeneration system

F1	Number of regeneration valves	6 pcs
F2	Size of regeneration valves	1"
F3	Total compressed air consumption	4 Nm <sup>3</sup> /h
F4	Compressed air pressure	6 bar

## Dimensions of the filtration device

G1	Total width of the filter	1 518 mm
G2	Total filter depth	1 453 mm
G3	Total filter height	5 500 mm
G4	Weight of the filter device	1 922 kg
G5	Emergency weight 1/3 hopper	77 kg
G6	Total weight incl. emergency filling	1 999 kg
G7	Foot load	4x 500 kg

## Dimensions of connecting flanges

H1	Contaminated gas inlet flange	Ø300 mm
H2	Clean gas outlet flange	250 x 250 mm
H3	Hopper connecting flange	250 x 250 mm
H4	Filter foot size	250 x 250 mm

## Material design of the filter

I1	Filter chamber material	11375
I2	Hopper material	11375
I3	Filter housing material thickness	3 mm
I4	Hopper material thickness	4 mm
I5	Thickness of stiffeners	5 mm
I6	Coating system	C4

## Material of thermal insulation

J1	Type of thermal insulation	<i>mineral wool</i>
J2	Coefficient of thermal conductivity	0,038 W/m.K
J3	Insulation thickness	100 mm
J4	Insulation cover	<i>galvanized sheet metal</i>
J5	Total insulation area of the cabinet	19,6 m <sup>2</sup>
J6	Total insulation area of the hopper	3,8 m <sup>2</sup>

## Hopper heating

K1	Hopper heating system	<i>electric resistance cable</i>
K2	The total area of the heated part	3,5 m <sup>2</sup>
K3	Heating power per 1 m <sup>2</sup>	200 W
K4	Total heating power	700 W



# TECHNICAL DATA SHEET - G&G Bag HOUSE FILTER

Filter type:

G&G-Bag-HOUSE-6-6-152-25-A

Producer:

G&G filtration CZ, s.r.o.

## Orientation drawing

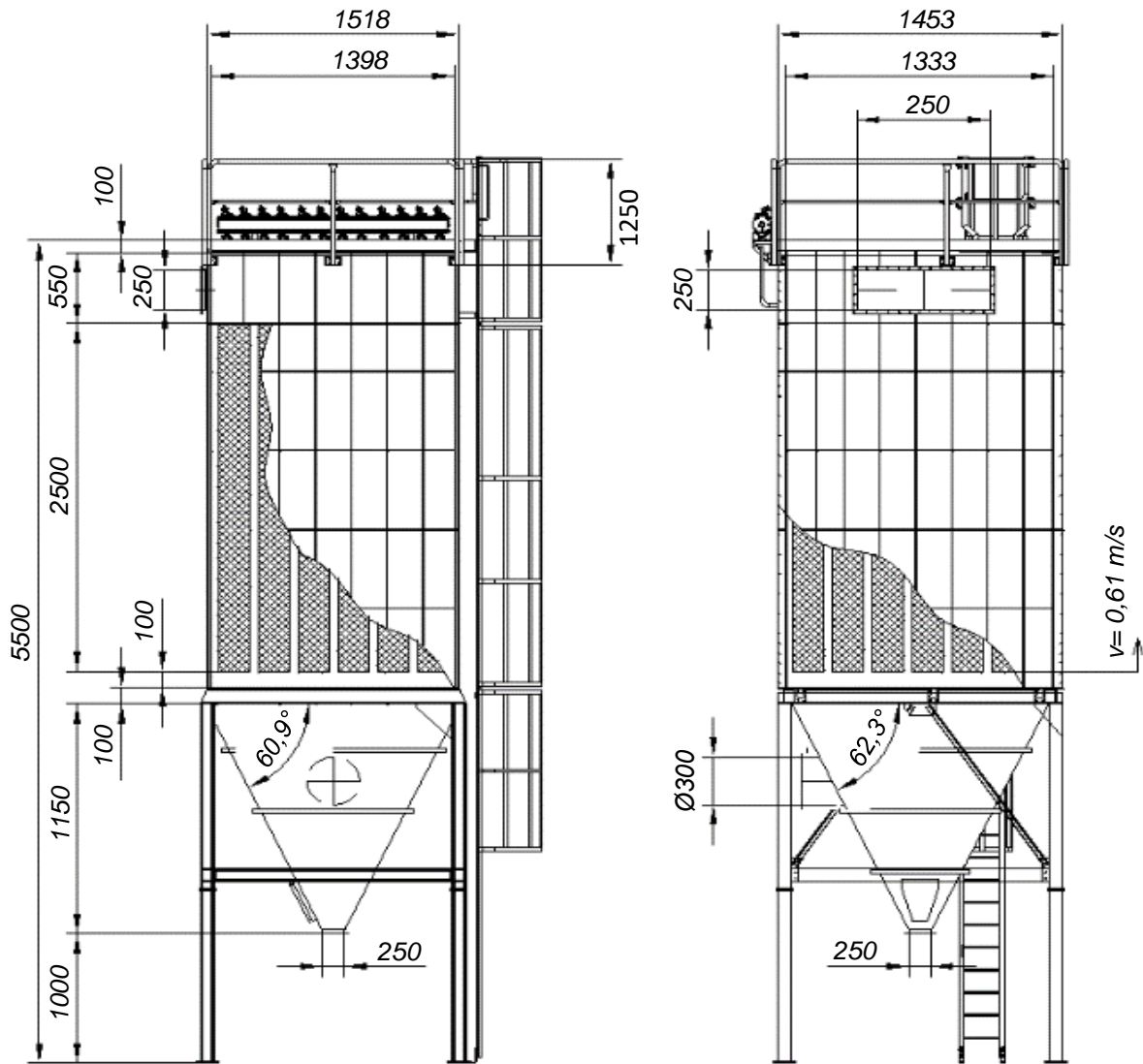

$m=1922 \text{ kg}$

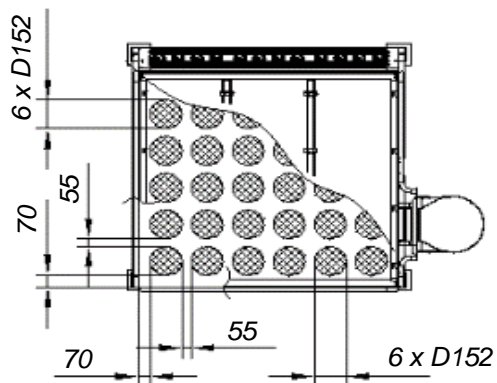

*this is an orientation drawing*

## Files for download

STEP: <https://download.ggfiltration.com/G&G-Bag-HOUSE-6-6-152-25-A.step>

DWG: <https://download.ggfiltration.com/G&G-Bag-HOUSE-6-6-152-25-A.dwg>



G&G filtration CZ, s.r.o.  
Hrubínova 1903/9  
664 51 Šlapanice  
Czech republic

IČO: 05226953  
DIČ: CZ05226953  
info@gg.cz  
info@ggfiltration.com