

TECHNICAL DATA SHEET - G&G Bag HOUSE FILTER

Filter type:	G&G-Bag-HOUSE-8-8-152-30-A
Producer:	G&G filtration CZ, s.r.o.

Parameters of filtered gas

A1	Operating amount of filtered gas	5 600 m ³ /h
A2	Operating temperature	20 °C
A3	Amount of filtered gas (0°C)	5 220 Nm ³ /h
A4	Inlet dust concentration	300 g/m ³
A5	Operating pressure drop	1 200 Pa
A6	Maximum pressure drop	2 200 Pa

Filter media parameters

B1	Shape of filter medium	round hoses
B2	Type of filter medium	m-Aramid
B3	Density of filter medium	530 g/m ²
B4	Breathability filter media	300 mm/s @ 200 Pa
B5	Continuous temperature resistance	200 °C
B6	Momentary temperature resistance	220 °C

Filter equipment parameters

C1	Number of filter rods	64 ks
C2	Total filter area	92 m ²
C3	A/C parameter	1,02 m ³ /m ² /min
C4	Can velocity	0,78 m/s
C5	Flow from below the rods	5 600 m ³ /h
C6	Hose side flow	- m ³ /h
C7	Polluted gas input	<i>into the filter hopper</i>

Dimensions of the filter part

D1	X-axis filter size	1 806 mm
D2	Y-axis filter size	1 741 mm
D3	The gap between the individual rods	55 mm
D4	Gap between filter rods with filter walls	70 mm
D5	Gap between rods and hopper	100 mm

Filter media arrangement

E1	Orientation of filter rods	<i>vertical</i>
E2	Diameter of filter rods	152 mm
E3	Length of filter rods	3 000 mm
E4	Rods attachment	<i>snapping</i>
E5	Inlet nozzle shape	<i>venturi</i>

Regeneration system

F1	Number of regeneration valves	8 pcs
F2	Size of regeneration valves	1"
F3	Total compressed air consumption	9 Nm ³ /h
F4	Compressed air pressure	6 bar

Dimensions of the filtration device

G1	Total width of the filter	1 954 mm
G2	Total filter depth	1 889 mm
G3	Total filter height	6 490 mm
G4	Weight of the filter device	3 115 kg
G5	Emergency weight 1/3 hopper	138 kg
G6	Total weight incl. emergency filling	3 253 kg
G7	Foot load	4x 814 kg

Dimensions of connecting flanges

H1	Contaminated gas inlet flange	Ø400 mm
H2	Clean gas outlet flange	400 x 400 mm
H3	Hopper connecting flange	250 x 250 mm
H4	Filter foot size	250 x 250 mm

Material design of the filter

I1	Filter chamber material	11375
I2	Hopper material	11375
I3	Filter housing material thickness	4 mm
I4	Hopper material thickness	4 mm
I5	Thickness of stiffeners	5 mm
I6	Coating system	C4

Material of thermal insulation

J1	Type of thermal insulation	mineral wool
J2	Coefficient of thermal conductivity	0,038 W/m.K
J3	Insulation thickness	100 mm
J4	Insulation cover	galvanized sheet metal
J5	Total insulation area of the cabinet	30,8 m ²
J6	Total insulation area of the hopper	6,5 m ²

Hopper heating

K1	Hopper heating system	electric resistance cable
K2	The total area of the heated part	6 m ²
K3	Heating power per 1 m ²	200 W
K4	Total heating power	1200 W



TECHNICAL DATA SHEET - G&G Bag HOUSE FILTER

Filter type:

G&G-Bag-HOUSE-8-8-152-30-A

Producer:

G&G filtration CZ, s.r.o.

Orientation drawing

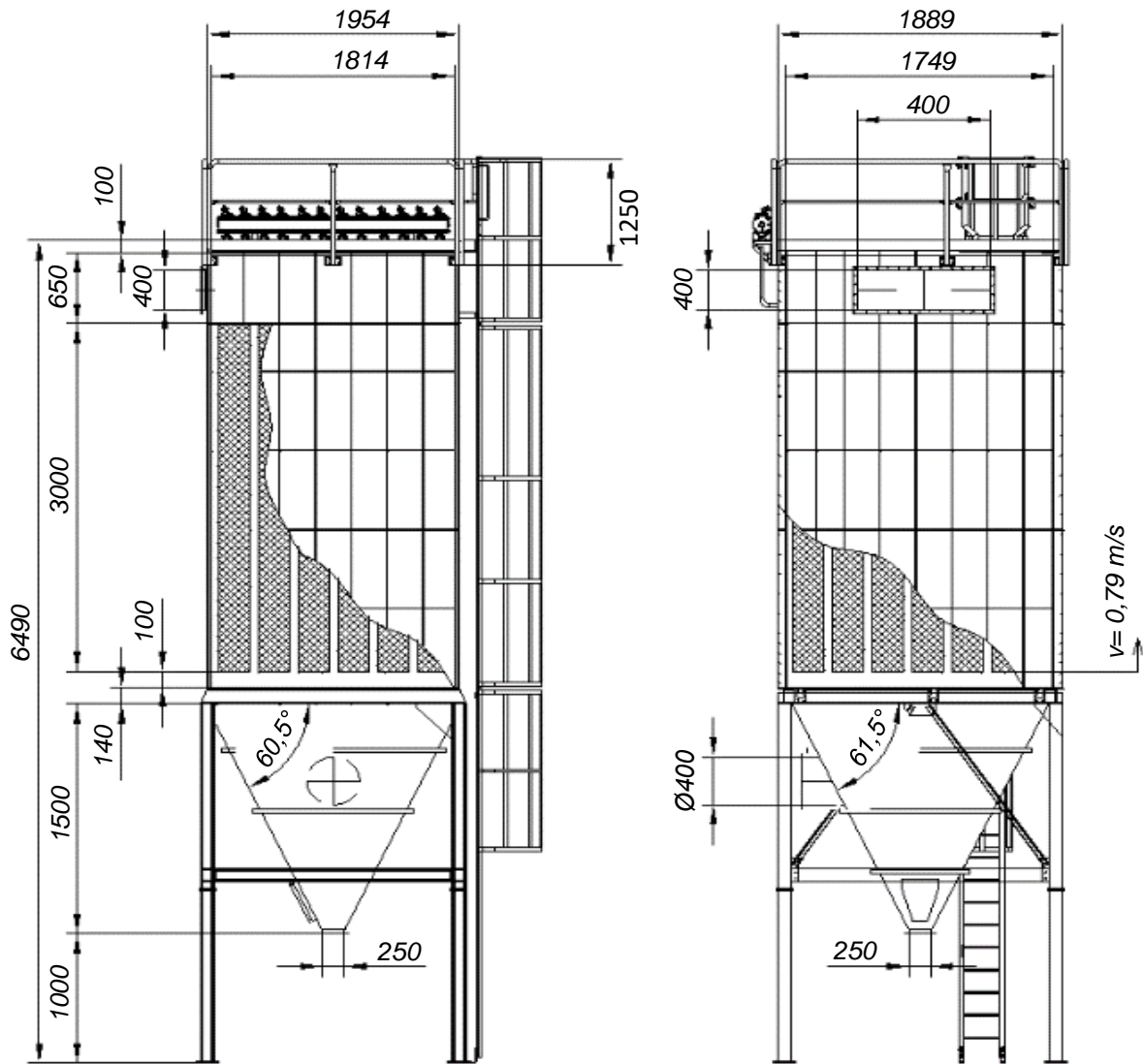

$m=3115 \text{ kg}$

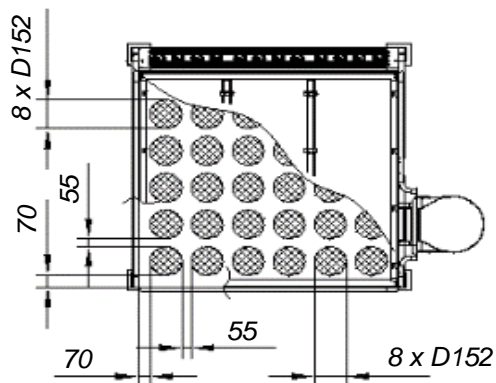

this is an orientation drawing

Files for download

STEP: <https://download.ggfiltration.com/G&G-Bag-HOUSE-8-8-152-30-A.step>

DWG: <https://download.ggfiltration.com/G&G-Bag-HOUSE-8-8-152-30-A.dwg>



G&G filtration CZ, s.r.o.
Hrubínova 1903/9
664 51 Šlapanice
Czech republic

IČO: 05226953
DIČ: CZ05226953
info@gg.cz
info@ggfiltration.com